

Project Diagrams

## SHAKER STYLE FIREPLACE SURROUND

v1.0



These diagrams are intended to supplement the project instructions found here:  
[projectbilld.com/blog/shaker-style-fireplace-surround](https://projectbilld.com/blog/shaker-style-fireplace-surround)

To help keep these designs free, be sure to [subscribe](#), consider [donating](#), and share where you got the inspiration from!

## Contents

OVERVIEW.....	3
SURROUND LEGS.....	4
APRON.....	6

## OVERVIEW

### Front View

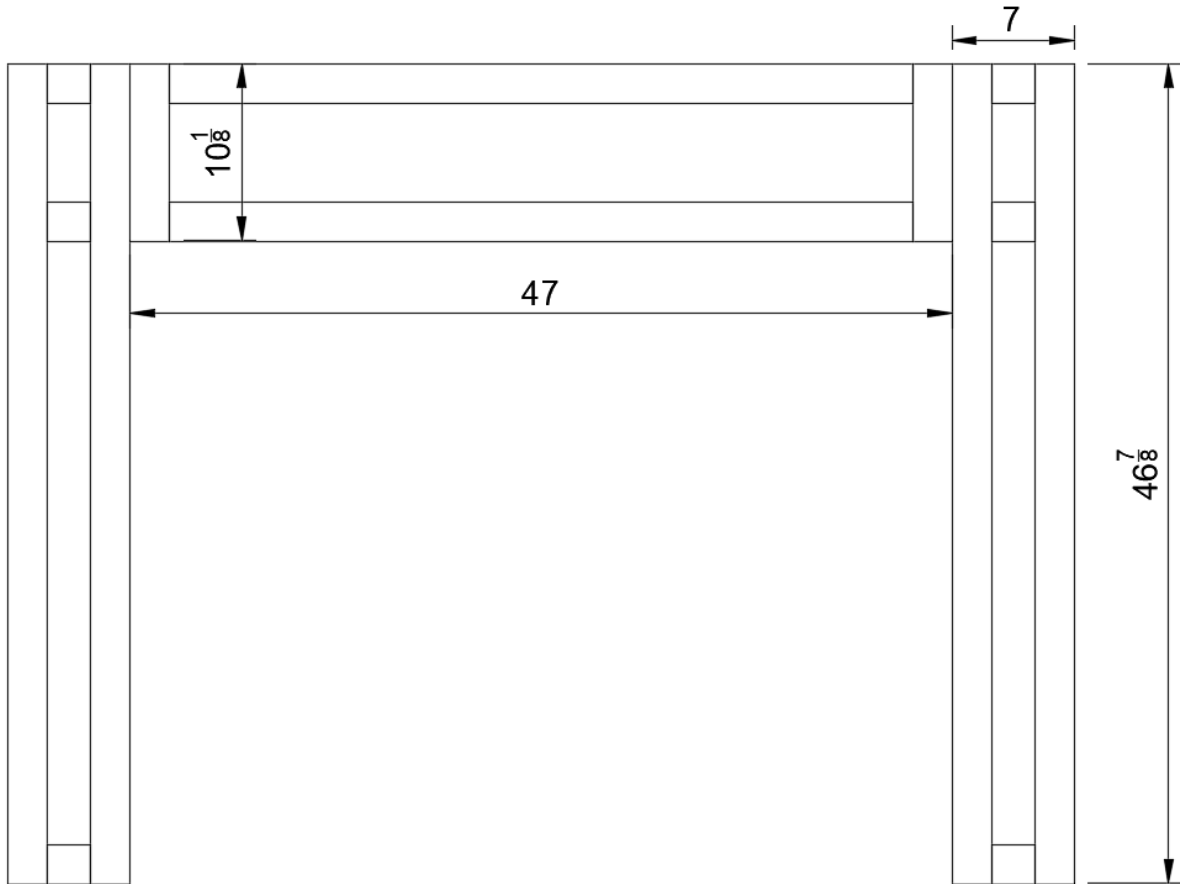

### Top View



### Notes

1. The top of a mantel is typically located at 54 inches from the floor but does vary based on the room. With a 6-inch beam mantel on top of the surround, mine is located around 53" from the floor/hearth, so if you want something different, then modify the lengths of the surround legs accordingly.
2. My surround has a 47 inch wide apron, and two 7 inch wide legs (which are pretty narrow). I was constrained by the existing fireplace and outlets on either side of the surround so feel free to change the dimensions, in particular, making the legs wider.

# SURROUND LEGS

## Parts List

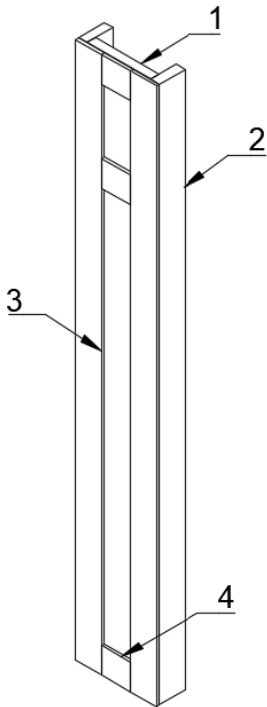

ITEM	QTY	DESCRIPTION	DIMENSIONS (IN)
1	1	Leg Face	46 <sup>7</sup> / <sub>8</sub> x 5 <sup>1</sup> / <sub>2</sub> x <sup>3</sup> / <sub>4</sub>
2	2	Leg Sides	46 <sup>7</sup> / <sub>8</sub> x 2 <sup>1</sup> / <sub>4</sub> x <sup>3</sup> / <sub>4</sub>
3	2	Stiles	46 <sup>7</sup> / <sub>8</sub> x 2 <sup>1</sup> / <sub>4</sub> x <sup>1</sup> / <sub>4</sub>
4	3	Rails	2 <sup>1</sup> / <sub>2</sub> x 2 <sup>1</sup> / <sub>4</sub> x <sup>1</sup> / <sub>4</sub>

Note: Quantities listed are per each leg, double to make 2 legs for the surround

Front and Side Views

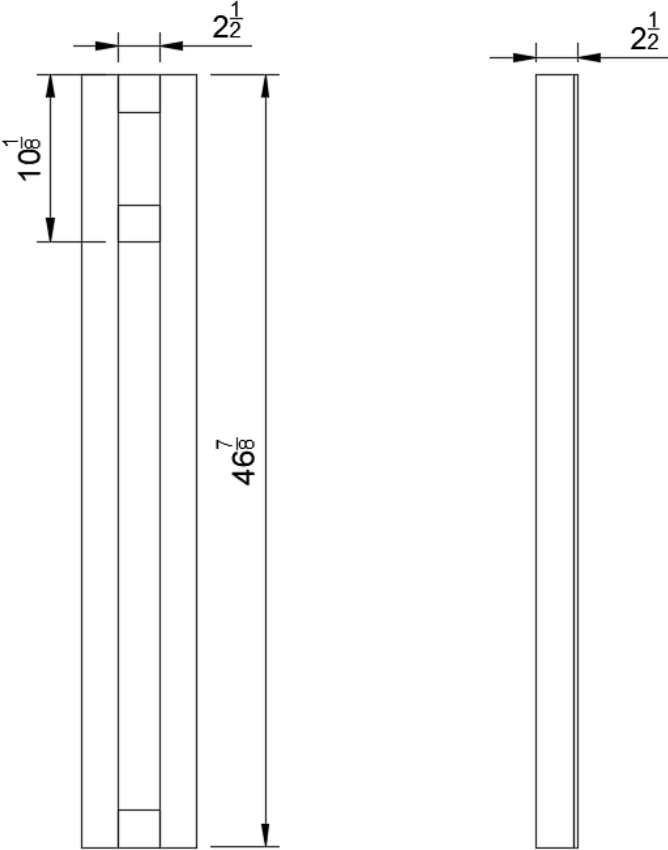

Top View

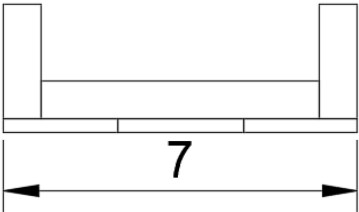

# APRON

## Parts List

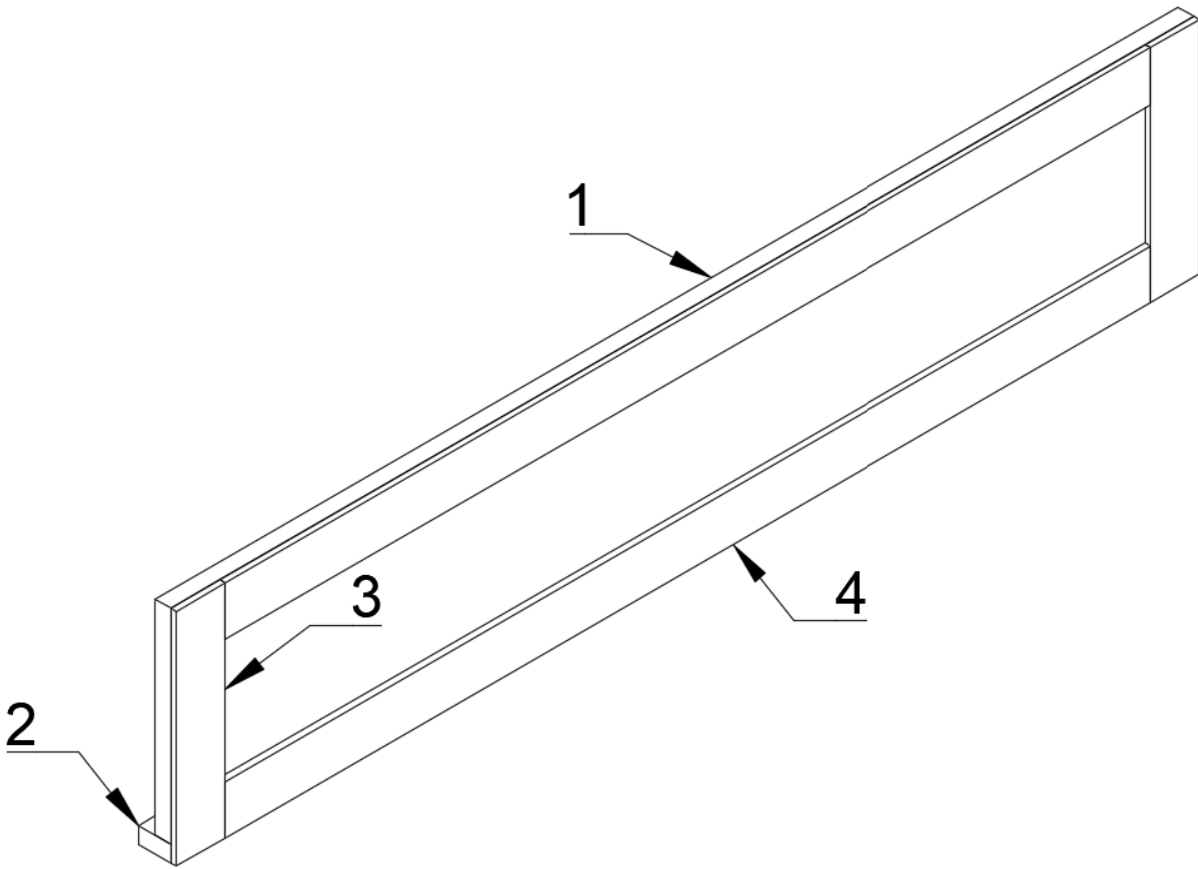

ITEM	QTY	DESCRIPTION	DIMENSIONS (IN)
1	1	Apron Face	47 x 9 $\frac{3}{8}$ x $\frac{3}{4}$
2	1	Apron Lip	47 x 1 $\frac{1}{2}$ x $\frac{3}{4}$
3	2	Stiles	10 $\frac{1}{8}$ x 2 $\frac{1}{4}$ x $\frac{1}{4}$
4	2	Rails	42 $\frac{1}{2}$ x 2 $\frac{1}{4}$ x $\frac{1}{4}$

Front View

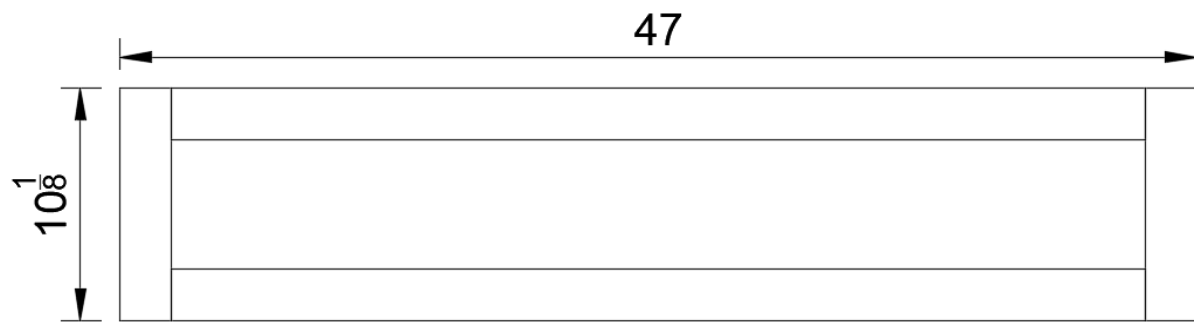

Side View

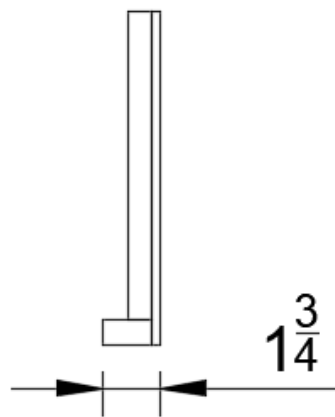

If you enjoyed the plans, please consider supporting my work by [donating to Project Billd](#).

If you have any questions about dimensions or find a mistake in these diagrams, please contact me via email using my contact page at [projectbilld.com/contact](mailto:projectbilld.com/contact) and I'll get back to you as soon as possible!

Happy billding!

-Bill